



## Basic Neurourology

EC2, 29 August 2011 09:00 - 12:00

Start	End	Topic	Speakers
09:00	09:20	Neurogenic lower urinary tract (LUT) dysfunction	<ul style="list-style-type: none"> <li>John Heesakkers</li> </ul>
09:20	09:30	Discussion	All
09:30	09:50	Diagnostic workup - How informative are basic diagnostics, are urodynamics essential?	<ul style="list-style-type: none"> <li>Jean Jacques Wyndaele</li> </ul>
09:50	10:00	Discussion	All
10:00	10:10	How to maintain normal renal function, how to achieve continence/to manage incontinence	<ul style="list-style-type: none"> <li>Helmut Madersbacher</li> </ul>
10:10	10:30	Management of the overactive detrusor, combined with overactive sphincter, underactive sphincter and normal sphincter	<ul style="list-style-type: none"> <li>Piotr Radziszewski</li> </ul>
10:30	11:00	Break	None
11:00	11:10	Discussion	All
11:10	11:30	Management of the underactive (acontractile) detrusor, combined with overactive sphincter, underactive sphincter and normal sphincter	<ul style="list-style-type: none"> <li>Helmut Madersbacher</li> </ul>
11:30	12:00	General Discussion	All

### **Aims of course/workshop**

In the first part information on neurophysiology of the lower urinary tract and on pathophysiology related to cerebral, spinal and peripheral lesions and how they are reflected in clinical symptoms are provided. There after a standard diagnostic approach will be presented and the value of the classic urodynamic techniques discussed.

In the second part an overview on the therapeutic strategies in 2011 in patients (1) with an overactive detrusor and (2) with an underactive detrusor, each combined either with an underactive sphincter, an overactive sphincter or a normal sphincter will be given.

### **Educational Objectives**

Having participated in this course, which will also include case presentations discussed with the audience, you should have a basic knowledge on neurogenic lower urinary tract dysfunction, its pathophysiology, its diagnostic workup, moreover you should be aware what can be offered to the individual patient nowadays.

## **Neurogenic Lower Urinary Tract Dysfunction**

*– from Neurophysiology via Pathophysiology to Clinics*

John PFA Heesakkers, MD PhD  
Urologist  
Radboud University Nijmegen MC  
Nijmegen  
The Netherlands  
j.heesakkers@uro.umcn.nl

Acknowledgement to:

Yasuhiko Igawa, MD, PhD  
Associate Professor, Department of Urology  
Shinshu University School of Medicine  
Matsumoto  
Japan  
[yxigawa@hsp.md.shinshu-u.ac.jp](mailto:yxigawa@hsp.md.shinshu-u.ac.jp)

---

## **INTRODUCTION**

The lower urinary tract (LUT), the urinary bladder and urethra, serves two reciprocal functions: storage of urine without leakage and periodic evacuation of urine. These two functions depend on central as well as peripheral autonomic and somatic neural pathways,<sup>1,2</sup> but also on voluntary control which requires the participation of higher centers in the brain. Because of the complex neural regulations, the central and peripheral nervous control of the LUT is prone to a variety of neurological disorders. In this lecture the principals of neuronal control of the LUT function will be summarized as well as the pathophysiology of neurogenic LUT dysfunction in specific lesions.

## **NEUROPHYSIOLOGY OF THE LOWER URINARY TRACT**

### **Normal LUT function**

The LUT function can be divided in storage and voiding functions. Normal storage function includes 1) sensation bladder fullness, 2) postpone urination, 3) maintaining continence and 4) low bladder pressure. Normal voiding function means to void voluntarily and smoothly without straining or post-void residual.

### **Reflex pathways controlling urine storage and voiding**

Coordinated activities of the peripheral nervous system innervating the LUT during urine storage and voiding depend on multiple reflex pathways organized in the brain and spinal cord. The central

pathways regulating LUT function are organized as on-off switching circuits that maintain a reciprocal relationship between bladder and its outlet.<sup>1-3</sup>

### *The storage phase*

The accommodation of the bladder to increasing volumes of urine is primarily a passive phenomenon dependent on the intrinsic properties of the detrusor.<sup>1-4</sup> In addition to this passive accommodation mechanism, the afferent activity induced by bladder distention can trigger reflex activation of the sympathetic outflow to the LUT. It contributes to the storage mechanism that inhibits the parasympathetic efferent outflow to the bladder and promotes closure of the urethra through activation of  $\alpha_{1A}$ -adrenoceptors. Furthermore it facilitates relaxation of the detrusor via activation of  $\beta_2$ -adrenoceptors<sup>4</sup> (**Figure 1A**). This reflex is organized in the lumbosacral spinal cord. During bladder filling, the bladder afferent input also activates the pudendal motoneurons innervating the external urethral sphincter (EUS)<sup>3,5</sup> and increases EUS activity. The EUS motor neurons are also activated by urethral/perineal afferents in the pudendal nerve<sup>6</sup>. These excitatory sphincter reflexes are organized in the spinal cord. Moreover, a supraspinal urine storage center located in the dorsolateral pons sends descending excitatory inputs to the EUS motoneurons to increase urethral resistance<sup>7,8</sup> (**Figure 1A**).

### *The voiding phase*

The storage phase can be switched to the voiding phase either involuntarily or voluntarily. When bladder volume reaches the micturition threshold, bladder afferents in the pelvic nerves trigger the micturition by acting on neurons in the sacral spinal cord, which then send their axons rostrally to the periaqueductal gray (PAG), which in turn communicates with the pontine micturition center (PMC)<sup>9,10</sup>. Activation of the PMC reverses the pattern of efferent outflow to the LUT, inhibiting sympathetic and somatic pathways and activating parasympathetic pathways. The voiding phase consists of an initial relaxation of the urethral sphincter followed by a contraction of the bladder. Thus voiding reflexes depend on a spinobulbospinal pathway (**Figure 1B**). Secondary reflexes elicited by urine flow into the urethra also facilitate bladder emptying.<sup>1,3</sup> Inhibition of EUS activity during voiding depends, at least in part, on supraspinal mechanisms.

## **Peripheral and spinal pathways**

The peripheral nervous mechanisms for bladder emptying and urine storage involve efferent and afferent signaling in pelvic (parasympathetic), hypogastric (sympathetic) and pudendal (somatic) nerves.<sup>1,2</sup> (**Figure 2**).

### *Efferent pathways of the LUT*

#### 1. Parasympathetic pathways

Pelvic parasympathetic nerves, which arise at the sacral spinal cord (S<sub>2</sub>-S<sub>4</sub>), provide an excitatory input to the bladder and an inhibitory input to the bladder neck and urethral smooth muscle to eliminate urine<sup>1,2,11</sup> (**Figure 2**). Parasympathetic preganglionic neurons send axons to peripheral ganglia. Parasympathetic postganglionic neurons in humans are located in the bladder wall.<sup>3</sup> Parasympathetic postganglionic nerve terminals release Acetylcholine (ACh), which can excite muscarinic receptors in the detrusor smooth muscle cells, leading to bladder contractions.<sup>12,13</sup> The postganglionic parasympathetic input to the urethra elicits inhibitory effects mediated at least in

part through the release of nitric oxide (NO), which directly relaxes the urethral smooth muscle.<sup>3,14,15</sup> Therefore, the excitation of sacral parasympathetic efferent pathways induces a bladder contraction and urethral relaxation to promote bladder emptying during micturition.

## 2. Sympathetic pathways

Hypogastric sympathetic nerves, which arise at the thoraco-lumbar level of the spinal cord (Th<sub>11</sub>-L<sub>2</sub>), provide a noradrenergic inhibitory input to the bladder and excitatory input to the urethra to facilitate urine storage<sup>3</sup> (**Figure 2**). The sympathetic activation causes inhibition of the parasympathetic pathways at spinal and ganglionic levels, and releases noradrenaline (NA) from its postganglionic terminals, which elicit relaxation the bladder body and contractions of the bladder neck and urethral smooth muscle<sup>3</sup>.

## 3. Somatic pathways

Somatic efferent motoneurons which activate the external striated urethral sphincter muscle and the pelvic floor muscle are located along the lateral border of the ventral horn in the sacral spinal cord (S<sub>2</sub>-S<sub>4</sub>), commonly referred to as the Onuf's nucleus<sup>16</sup> (**Figure 2**). The somatic motoneurons send axons into the pudendal nerves. Combined activation of sympathetic and somatic pathways increases bladder outlet resistance and realises urinary continence.

### *Afferent pathways of the LUT*

The pelvic, hypogastric, and pudendal nerves also contain afferent axons that transmit information from the LUT to the spinal cord (**Figure 2**).<sup>1,2,17,18</sup> The pelvic afferent nerves, which monitor the volume of the bladder and intravesical pressure, consist of small myelinated A $\delta$  and unmyelinated C fibers. Normal micturition reflex is mediated by myelinated A $\delta$  fibers, which respond to bladder distention and active contraction<sup>3,18,19</sup> (**Figure 3**). The activation threshold for A $\delta$  fibers is 5-15 cmH<sub>2</sub>O<sup>1</sup>. C-fiber afferents have a high mechanical threshold and are usually unresponsive to mechanical stimuli such as bladder distention<sup>19</sup> and therefore have been termed as "silent C fibers". However, these fibers respond primarily to chemical, noxious, or cold stimuli. During inflammation or neuropathic conditions, there is recruitment of C-fiber bladder afferents, which form a new afferent pathway that can cause detrusor overactivity and bladder pain<sup>20</sup> (**Figure 3**).

### **Brainstem (Pons)**

The dorsal pontine tegmentum has been established as an essential control center for micturition and called as the "pontine micturition center (PMC)" or the "M region" due to its median location.<sup>10,21,22</sup> Brain imaging studies have revealed increase in blood flow in this region of the pons during micturition.<sup>23</sup> Neurons in the PMC provide direct synaptic inputs to sacral PGN, as well as to GABA-nergic neurons in the sacral dorsal commissure (DCM).<sup>21</sup> The former neurons carry the excitatory outflow to the bladder, whereas the latter neurons are thought to be important in mediating an inhibitory outflow on EUS motoneurons during micturition<sup>24</sup>. As a result of these reciprocal connections, the PMC can promote coordination between the bladder and urethral sphincter. In the cat, another area, located in the ventrolateral pontine tegmentum and is called the "L-region", which controls the motoneurons of the pelvic floor, including the external urethral sphincter.<sup>25</sup> This region might be considered as the pontine storage center (**Figure 1A**). In humans the laterally located L-region is especially active in volunteers who tried but did not succeed to micturate.<sup>25,26</sup>

### **Suprapontine pathways**

Studies in humans indicate that voluntary control of urine storage and voiding depends on connections between the frontal cortex and the septal/preoptic region of the hypothalamus as well as connections the paracentral lobule and the brainstem.<sup>1, 3</sup> Lesions to these areas of cortex exhibit detrusor overactivity (DO) because of lack of cortical inhibitory control. Brain imaging studies in right-handed both male and female volunteers have demonstrated decreased blood flow in the right anterior cingulate gyrus during urine withholding prior micturition and increased blood flow in the right dorsomedial pontine tegmentum, in the PAG, in the hypothalamus and in the right inferior frontal gyrus during voiding.<sup>23, 26, 27</sup> It has been implicated that the midbrain PAG receives bladder filling information, and the hypothalamus has a role in the beginning of micturition.<sup>28</sup> Furthermore, the human cingulate and prefrontal cortices are activated during both micturition and continence, indicating that these areas are important for the onset of micturition, but not for the reflex itself.

## **PATHOPHYSIOLOGY OF THE LOWER URINARY TRACT DYSFUNCTION**

When a neurological lesion is present, the type of LUT dysfunction roughly depends on the site and the extent of the lesion<sup>29</sup>.

Neurological pathology can be divided in 1) suprapontine, 2) brainstem (pontine), 3) suprasacral spinal cord, and 4) sacral and subsacral (cauda equine and peripheral nerve) lesions (**Figure 4**). Madersbacher et al described the common patterns of neurogenic detrusor-sphincter dysfunction in a diagram associated with these lesions (**Figure 5**).<sup>30</sup>

### **Suprapontine lesions**

Patients with lesions above the pons commonly demonstrate DO caused by lack of cortical inhibitory control, but they preserve coordinated synergic sphincter function (**Figure 5-A**). However, these patients sometimes may purposely increase sphincter activity during an overactive detrusor contraction to avoid urgency incontinence<sup>31</sup>. Typical suprapontine lesions include cerebro-vascular accident (CVA), dementia, brain tumors, and cerebral palsy.

#### *Cerebro-vascular accident (CVA)*

The most common LUT symptoms after stroke are nocturia (36%), urge incontinence (29%) and difficulty in voiding (25%)<sup>32</sup>. There is a positive correlation between the occurrence of LUT dysfunction and hemiparesis<sup>32</sup>. Urodynamic studies revealed DO in 68%, uninhibited sphincter relaxation in 36%<sup>32</sup>. In patients with brainstem strokes, voiding symptoms are more predominant<sup>33</sup>.

### **Brainstem (pontine) lesions**

As the pontine micturition center (PMC) and the lateral storage centre are located in the brain stem, lesions of this area demonstrate a variety of LUT dysfunction. Both storage and voiding dysfunctions often occur simultaneously. The common diseases of this region include Parkinson's disease, multiple system atrophy (MSA), and multiple sclerosis.

#### *Parkinson's disease*

LUT dysfunction occurs in 37-71% of patients<sup>39,40</sup>. Storage symptoms were observed in 28%, voiding symptoms in 11%, and both symptoms in 21%<sup>40</sup>. The frequency of LUT symptoms correlated with the severity of the disease, but not with the duration of the illness or sex<sup>40</sup>. DO was observed in 81%, external sphincter relaxation failure in 33%, and underactive detrusor in 66% of women and 40% of men<sup>41</sup>.

### *Multiple system atrophy (MSA)*

MSA involves various syndromes resulted from degeneration of neurons and associated fibers of motor and extrapyramidal systems including the cerebellum and brain stem. LUT symptoms often precede orthostatic hypotension and other autonomic nervous system symptoms in MSA patients<sup>42</sup>. Almost 100% of MSA patients have some kind of LUT symptoms<sup>43,44</sup>. The most common urodynamic abnormalities are abnormal sphincter EMG (in 82-91%)<sup>42,44,45</sup>, DO (in 56%)<sup>44</sup>, DSD (in 45-47%)<sup>44,46,47</sup>, uninhibited external sphincter relaxation (in 33%)<sup>44</sup>, and underactive detrusor (in 71% of women and 63% of men)<sup>44</sup>. Significant PVR is observed in about half of MSA patients<sup>48</sup>.

### **Suprasacral spinal cord lesions**

Spinal lesions mostly cause simultaneous dysfunction of the detrusor and the sphincter. In suprasacral spinal cord lesions a typical pattern of the LUT dysfunction is DO associated with DSD (**Figure 5-B**). If the lesion is complete, sensation of bladder filling disappears. Basically spontaneous reflex voiding is possible, however, it is uncontrolled, causing reflex incontinence, and unphysiological. DSD leads to unbalanced voiding with the possibility of a dangerous high pressure situation. While most traumatic spinal cord lesions give LUT dysfunction which can be predicted fairly well from the level and completeness of injury, the LUT dysfunction in many other neurological disorders such as myelomeningocele are more difficult to categorise<sup>29</sup> (**Figure 5-B, C, E & F**).

### *Spinal cord injury (SCI)*

DO was demonstrated in 95%<sup>49</sup>, and DSD in 68%<sup>50</sup> of the patients with suprasacral lesions. In patients with sacral lesion, an acontractile detrusor was found in 86%, and low compliance in 79%<sup>49</sup>. Upper urinary tract changes were observed in 30-42% of SCI patients<sup>51,52</sup>.

### *Multiple sclerosis (MS)*

The LUT dysfunction is mainly due to spinal lesions, although brain lesions may contribute<sup>30</sup>. Impairment of neurological function results from demyelinating plaques of the white matter of the brain and spinal cord, especially the posterior and lateral columns of the cervical cord. The prevalence of LUT dysfunction in MS patients is 33-52%, and its incidence is related to the disability status<sup>53</sup>. Urodynamic studies revealed DO in 44-99%, DSD in 6-66%, and detrusor underactivity in 31-38%<sup>54-56</sup>. The upper urinary tract is rarely involved<sup>57</sup>.

### **Sacral and subsacral (cauda equina and peripheral nerves) lesions**

Lesions of conus causing dysfunction of the sacral parasympathetic neurons and the EUS motoneurons are categorized as the same group as subsacral (cauda equina and peripheral nerves) lesions. For complete sacral or subsacral lesions, classically named as lower motor neuron lesions, loss of bladder sensation and acontractile detrusor with incompetent urethra are characteristic

(**Figure 5-E**). However, acontractile detrusor combined with normal or overactive urethra may occur in lesions, comprising the conus and nearby area above (**Figure 5-D & F**). In lumbo-sacral lesions, especially in myelomeningocele, overactive detrusor combined with incompetent urethra sometimes occur (**Figure 5-C**). Subsacral (cauda equina and peripheral nerves) lesions are often incomplete and associated with a variety of combination patterns of the detrusor and urethral dysfunctions. For example, in case of pelvic nerve plexus injury after radical pelvic organ surgery, if the pudendal nerves remain intact, impaired bladder sensation and underactive/contractile detrusor may be combined normally functioning urethra (**Figure 5-D**). On the other hand, the pudendal nerves are selectively disrupted, for instance, in traumatic pelvic fracture, incompetent urethra may occur with normal detrusor function (**Figure 5-H**)

#### *Myelodysplasia (Myelomeningocele MMC) and spina bifida*

The incidence of LUT dysfunction is very high (>90%) in MMC patients<sup>29</sup>. Most have LUT dysfunction leading to incontinence and/or upper tract deterioration.

#### *Diabetes Mellitus*

There are no proper epidemiological studies on the incidence of diabetes-related LUT dysfunction. Neurogenic LUT dysfunction occurs in 43-87% of insulin-dependent DM patients with no sex or age differences<sup>58</sup>. LUT dysfunction is characterized as reduced bladder sensation and impaired emptying function due to detrusor underactivity<sup>59-61</sup>.

#### *Peripheral neuropathy after pelvic surgery*

No good epidemiological studies on the incidence of LUT dysfunction related with peripheral nerve injury in pelvic surgery were performed. Neurogenic LUT dysfunction occurs in 30-50% of patients after extensive pelvic surgery. LUT dysfunction is characterized as reduced bladder sensation, low compliant detrusor and impaired emptying function due to detrusor underactivity<sup>29</sup>.

---

## References

1. de Groat WC, Booth AM, Yoshimura N. Neurophysiology of micturition and its modification in animal models of human disease. In: Maggi CA, ed. The autonomic nervous system, Vol. 3, Nervous control of the urogenital system. London: Harwood Academic Publishers, 1993: 227-290.
2. Yoshimura N, de Groat WC. Neural control of the lower urinary tract. *Int J Urol* 1997; 4: 111-125.
3. Yoshimura N, Seki S, Chancellor MB. Integrated physiology of the lower urinary tract. In: Orcos J, Schick E, eds. Textbook of the neurogenic bladder. Adults and children, Martin Dunitz Ltd, London, UK, 2005: 73-87
4. Andersson K-E. Pharmacology of lower urinary tract smooth muscles and penile erectile tissues. *Pharmacol Rev* 1993; 45: 253-308.
5. Park JM, Bloom DA, McGuire EJ. The guarding reflex revisited. *Br J Urol* 1997; 80: 940-945.
6. Fedirchuk B, Hochman S, Shefchyk SJ. An intracellular study of perineal and hindlimb afferent inputs onto sphincter motoneurons in the decerebrate cat. *Exp Brain Res* 1992; 89: 511-516.
7. Holstege G, Griffiths D, De Wall H, Dalm E. Anatomical and physiological observations on supraspinal control of bladder and urethral sphincter muscles in the cat. *J Comp Neurol* 1986; 250: 449-461.

8. Kohama T. [Neuroanatomical studies on the urine storage facilitatory areas in the cat brain. Part I. Input neuronal structures to the nucleus locus subcoeruleus and the nucleus radicularis pontis oralis]. *Nippon Hinyokika Gakkai Zasshi* 1992; 83: 1469-1477.
9. Blok BF, Holstege G. Direct projections from the periaqueductal gray to the pontine micturition center (M-region). An anterograde and retrograde tracing study in the cat. *Neurosci Lett* 1994; 166: 93-96.
10. Blok BF, De Weerd H, Holstege G. Ultrastructural evidence for a paucity of projections from the lumbosacral cord to the pontine micturition center or M-region in the cat: a new concept for the organization of the micturition reflex with the periaqueductal gray as central relay. *J Comp Neurol* 1995; 359: 300-309.
11. de Groat WC, Nadelhaft I, Milne RJ, et al. Organization of the sacral parasympathetic reflex pathways to the urinary bladder and large intestine. *J Auton Nerv Syst* 1981; 3: 135-160.
12. Hegde SS, Eglén RM. Muscarinic receptor subtypes modulating smooth muscle contractility in the urinary bladder. *Life Sci* 1999; 64: 419-428.
13. Fetscher C, Fleischman M, Schmidt M, et al. M(3) muscarinic receptors mediate contraction of human urinary bladder. *Br J Pharmacol* 2002; 136: 641-644.
14. Lundberg JM. Pharmacology of cotransmission in the autonomic nervous system: integrative aspects on amines, neuropeptides, adenosine triphosphate, amino acids and nitric oxide. *Pharmacol Rev* 1996; 48: 113-178.
15. Bennett BC, Kruse MN, Roppolo JR, et al. Neural control of urethral outlet activity in vivo: role of nitric oxide. *J Urol* 1995; 153: 2004-2009.
16. Thor KB, Morgan C, Nadelhaft I, et al. Organization of afferent and efferent pathways in the pudendal nerve of the female cat. *J Comp Neurol* 1989; 288: 263-279.
17. de Groat WC. Spinal cord projections and neuropeptides in visceral afferent neurons. *Prog Brain Res* 1986; 67: 165-187.
18. Janig W, Morrison JFB. Functional properties of spinal visceral afferents supplying abdominal and pelvic organs, with special emphasis on visceral nociception. *Prog Brain Res* 1986; 67: 87-114.
19. Habler HJ, Janig W, Koltzenburg M. Activation of unmyelinated afferent fibres by mechanical stimuli and inflammation of the urinary bladder in the cat. *J Physiol* 1990; 425: 545-562.
20. Yoshimura N, Seki S, Chancellor MB, et al. Targeting afferent hyperexcitability for therapy of the painful bladder syndrome. *Urology* 2002; 59: 61-67.
21. Blok BFM, DeWeerd H, Holstege G. The pontine micturition center projects to sacral cord GABA immunoreactive neurons in the cat. *Neurosci Lett* 1997; 233: 109-112.
22. Blok BFM, Holstege G. Neuronal control of micturition and its relation to the emotional motor system. *Prog Brain Res* 1996; 107: 113-126.
23. Blok BFM, Willemsen ATM, Holstege G. A PET study on the brain control of micturition in humans. *Brain* 1997; 120: 111-121.
24. Blok BF, van Maarseveen JT, Holstege G. Electrical stimulation of the sacral dorsal gray commissure evokes relaxation of the external urethral sphincter in the cat. *Neurosci Lett* 1998; 249: 68-70.
25. Blok BF, Holstege G. The central nervous system control of micturition in cats and humans. *Behav Brain Res*. 1998; 92:119-25.
26. Blok BF, Sturms LM, Holstege G. Brain activation during micturition in women. *Brain*. 1998; 121: 2033-2042.
27. Blok BF, Sturms LM, Holstege G. A PET study on cortical and subcortical control of pelvic floor musculature in women. *J Comp Neurol* 1997; 389: 535-544.
28. Blok BF. Central pathways controlling micturition and urinary continence. *Urology*. 2002; 59(5 Suppl 1):13-17.
29. Wyndaele, J.J., Castro, D., Madersbacher, H., Chartier-Kastler, E., Igawa, Y., Kovindha, A., Radziszewski, P., Stone, A., Wiesel, P. Neurologic urinary and faecal incontinence. In: *Incontinence, 3rd Edition*, Abrams P, Cardozo L, Khoury S, Wein A (Eds.), Health Publication Ltd,



Edition 21, Paris, 2005; 1059-1162.

30. Madersbacher, H., Wyndaele, J.J., Igawa, Y., Chancellor, M., Chartier-Kastler, E., Kovindha, A. Conservative Management in neuropathic urinary incontinence. In: Incontinence, 2<sup>nd</sup> Edition, Abrams P, Khoury S, Wein A (Eds.), Health Publication Ltd, Plymouth, 2002: 697-754.
31. Siroky, M.B., Krane R.J. Neurologic aspects of detrusor-sphincter dyssynergia, with reference to the guarding reflex. *J Urol* 1982;127: 953-957.
32. Sakakibara, R., Hattori, T., Yasuda, K., Yamanishi, T.: Micturitional disturbance after acute hemispheric stroke: analysis of the lesion site by CT and MRI. *J Neurol Sci*, 137: 47, 1996
33. Sakakibara R., Hattori, T., Yasuda, K., Yamanishi, T.: Micturitional disturbance and the pontine tegmental lesion: urodynamic and MRI analyses of vascular cases. *J Neurol Sci*, 141: 105, 1996
34. Horimoto, Y., Matsumoto, M., Akatsu, H., Ikari, H., Kojima, K., Yamamoto, T. et al.: Autonomic dysfunctions in dementia with Lewy bodies. *J'Neural*, 250 :530, 2003
35. Toba, K., Ouchi, Y, Orimo, H., Iimura, O., Sasaki, H., Nakamura, Y. et al. : Urinary incontinence in elderly inpatients in Japan: a comparison between general and geriatric hospitals. *Aging*, 81 : 47,1996
36. Ouslander, J.G., Palmer, M.H., Rovner, B.W., German, P.S.: Urinary incontinence in nursing homes: incidence, remission and associated factors. *J Am Geriatr Soc* ,41: 1083, 1993
37. Resnick, N.M., Yalla, S.V., Laurino, E.: The pathophysiology of urinary incontinence among institutionalized elderly persons. *N Engl JMed* , 320:1, 1989
38. Yoshimura, N., Yoshida, O., Yamamoto, S., Mori, H., Majima, M., Mui, K.: Evaluation of urinary incontinence among the nursing home elderly. *Hinyokika Kyo*, 37: 689, 1991
39. Martignoni, E., Pacchetti, C., Godi, L., Micieli, G., Nappi, G.: Autonomic disorders in Parkinson's disease. *J Neural Transm Suppl*, 45:11, 1995
40. Hattori, T., Yasuda, K., Kita, K., Hirayama, K.:Voiding dysfunction in Parkinson's disease. *Jpn J Psychiatry Neurol*, 46:1: 181, 1992
41. Sakakibara, R., Hattori, T., Uchiyama, T., Yamanishi, T.: Videourodynamic and sphincter motor unit potential analyses in Parkinson's disease and multiple system atrophy. *J Neurol Neurosurg Psychiatry*, 71: 600, 2001
42. Kirshhof, K., Apostolidis, A.N., Mathias, C.J., Fowler, C.J.:Erectile and urinary dysfunction may be the presenting features in patients with multiple system atrophy: a retrospective study. *IntJ Impot Res*, 15 : 293, 2003
43. Sakakibara, R., Hattori, T., Tojo, M., Yamanishi, T., Yasuda, K.,Hirayama, K. Micturitional disturbance in multiple system atrophy. *Jpn J Psychiatry Neurol*, 47: 591, 1993
44. Sakakibara, R., Hattori, T., Uchiyama, T., Yamanishi, T.: Videourodynamic and sphincter motor unit potential analyses in Parkinson's disease and multiple system atrophy. *J Neurol Neurosurg Psychiatry*, 71 : 600, 2001
45. Palace, J., Chandiramani, V.A., Fowler, C.J.: Value of sphincter electromyography in the diagnosis of multiple system atrophy. *Muscle Nerve*, 20: 1396, 1997
46. Bonnet, A.M., Pichon, J., Vidailhet, M., Gouider-Khouja, N., Robain, G., Perrigot, M. et al.: Urinary disturbances in striatonigral degeneration and Parkinson's disease: clinical and urodynamic aspects. *Mov Disord*, 12: 509, 1997
47. Stocchi, K, Carbone, A., Inghilleri, M., Monge, A., Ruggieri, S., Berardelli, A. et al. : Urodynamic and neurophysiological evaluation in Parkinson's disease and multiple system atrophy. *J Neurol Neurosurg Psychiatry*, 62: 507, 1997
48. Sakakibara, R., Hattori, T., Uchiyama, T., Suenaga, T., Takahashi, H., Yamanishi, T. et al.: Are alpha-blockers involved in LUT dysfunction in multiple system atrophy? A comparison of prazosin and moxislyte. *J Auton Nerv Syst*, 79:191, 2000
49. Weld, K.J., Dmochowski, R.R.: Association of level of injury and bladder behavior in patients with post-traumatic spinal cord injury. *Urology*, 55: 490, 2000.
50. Perlow, D.L., Diokno, A.C.: Predicting LUT dysfunctions in patients with spinal cord injury. *Urology*, 18: 531, 1981.

51. Ruutu, M., Lehtonen, T.: Urinary tract complications in spinal cord injury patients. *Ann Chir Gynaecol*, 73: 325, 1984.
52. Ruutu, M., Kivisaari, A., Lehtonen, T.: Upper urinary tract changes in patients with spinal cord injury. *Clin Radiol*, 35: 491, 1984.
53. Bemelmans, B.L.H., Hommes, O.R., Van Kerrebroeck, P.E.V., Lemmens, W.A.J. G., Doesburg, W. H. Debruyne, F.M.J.: Evidence for early LUT dysfunction in clinically silent multiple sclerosis. *J Urol*, 145 : 1219, 1991
54. Araki, I., Matsui, M., Ozawa, K., Nishimura, M., Kuno, S., Saida, T.: Relationship between urinary symptoms and disease-related parameters in multiple sclerosis. *J Neurol*, 249: 1010, 2002.
55. Kim, H. Y, Goodman, Ch., Omessi, E., Rivera, V., Kattan, M.W., Boone, T.B.: The correlation of urodynamic findings with cranial magnetic resonance imaging findings in multiple sclerosis. *J Urol*, 159 : 972, 1998
56. Ukkonen, M., Elovaara, I, Dastidar, P., Tammela, T.L.: Urodynamic findings in primary progressive multiple sclerosis are associated with increased volumes of plaques and atrophy in the central nervous system. *Acta Neurol Scand*, 109: 100, 2004.
57. Koldewijn, E.L., Hommes, O.R., Lemmens, W.A.J.G., Debruyne, F.M.J., Van Kerrebroek, P.E.V.: Relationship between LUT abnormalities and disease-related parameters in multiple sclerosis. *J Urol*, 154: 169, 1995.
58. Frimodt-Moller, C.: Diabetic cystopathy: epidemiology and related disorders. *Ann Intern Med*, 92: 318, 1980.
59. Starer, P., Libow, L.: Cystometric evaluation of bladder dysfunction in elderly diabetic patients. *Arch Intern Med*, 150:810,1990
60. Kaplan, S.A., Te, A.E., Blaivas, J.G.: Urodynamic findings in patients with diabetic cystopathy. *J Urol*,152: 342, 1995.
61. Chancellor, M.B., Blaivas, J.G.: Diabetic neurogenic bladder. In: Chancellor MB, Blaivas JG,(eds): *Practical neur-urology*. Boston, Butterworth-Heinemann, 1995, pp149- 154.

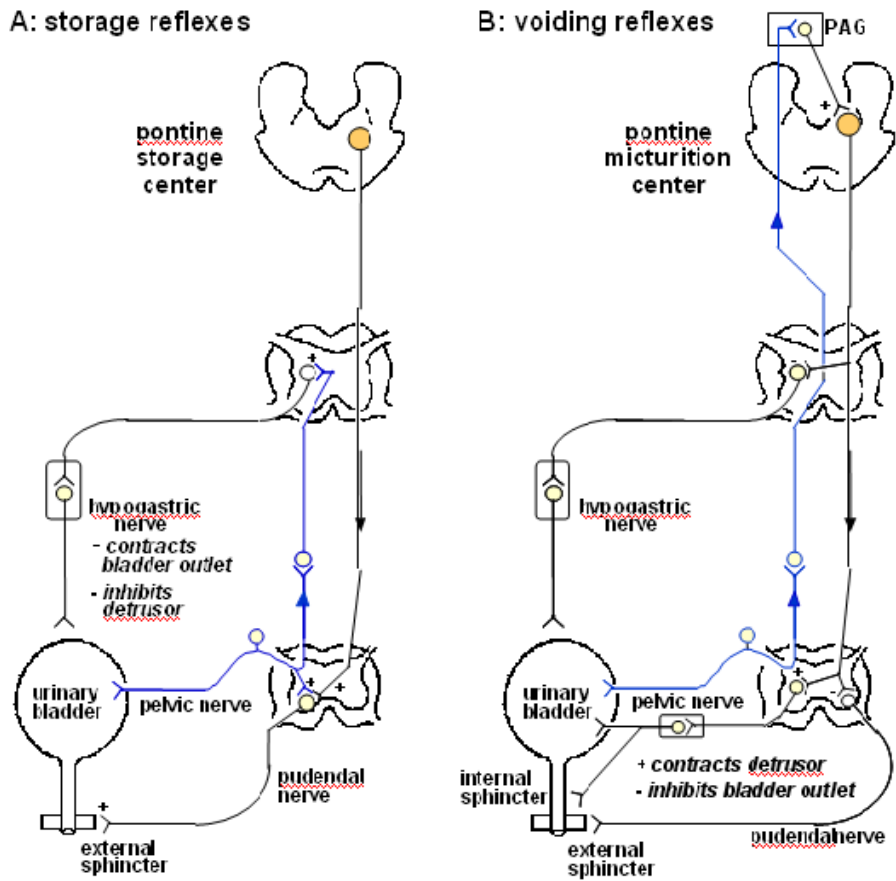

Figure 1. Neural circuits controlling continence and micturition. A: Storage reflexes, B: Voiding reflexes (Modified from Yoshimura & de Groat<sup>2</sup>)

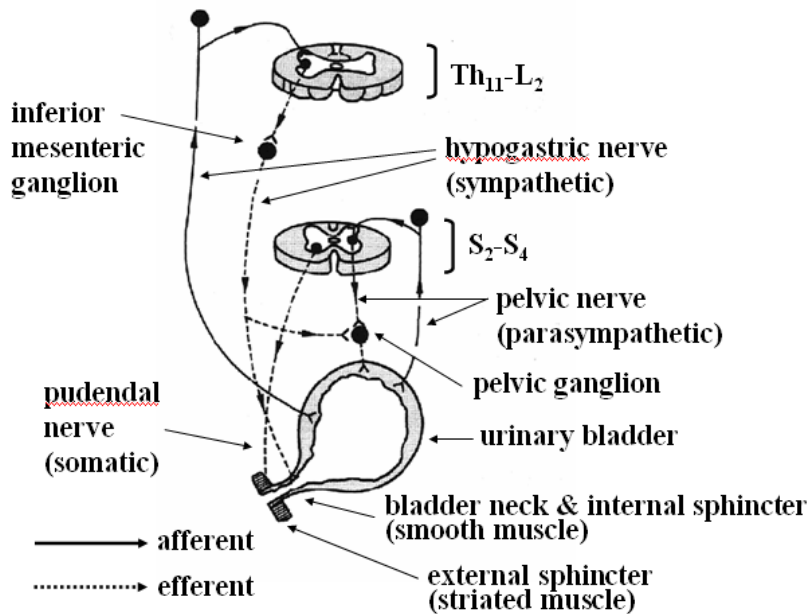

Figure 2. Sympathetic, parasympathetic, and somatic innervation of the lower urinary tract. (Reproduced from Yoshimura & de Groat<sup>2</sup>)

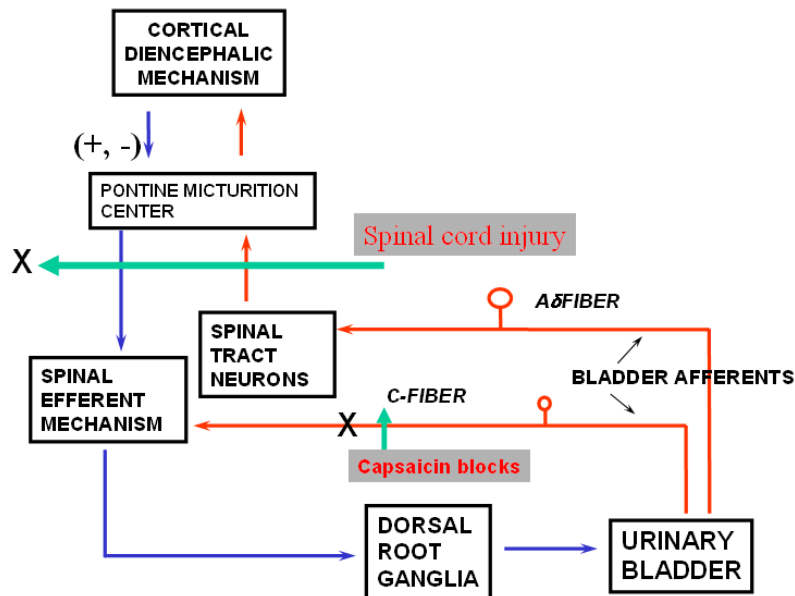

Figure 3. The central reflex pathways that regulate micturition in normal and spinal-cord-injured cats (Modified from Yoshimura et al<sup>3</sup>)

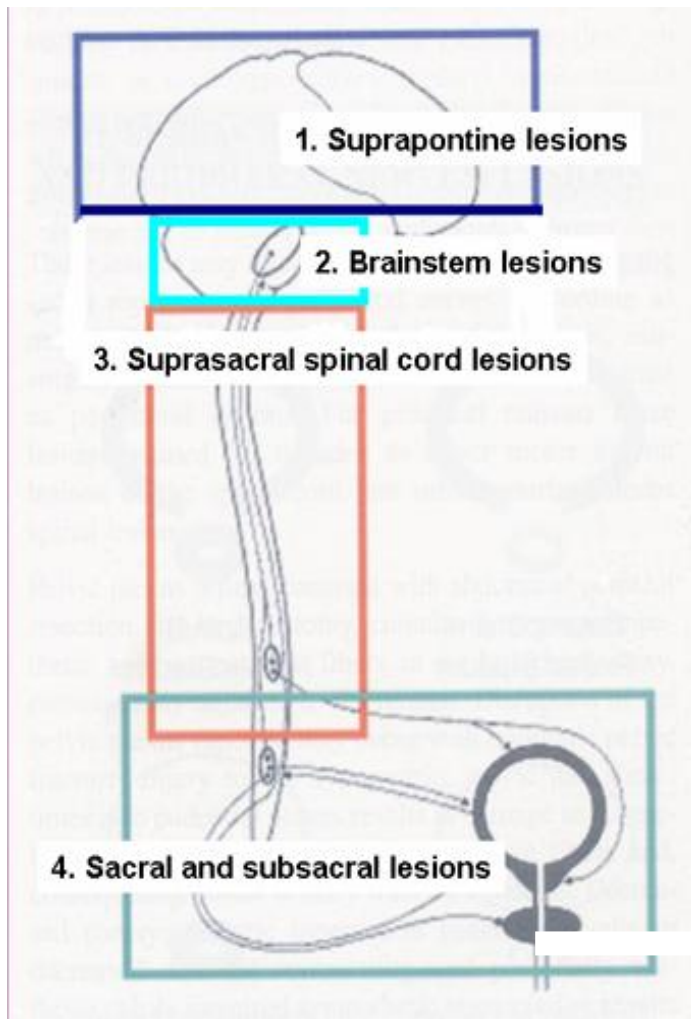

Figure 4. Classification of neurological lesions (Modified from Madersbacher et al<sup>30</sup>)

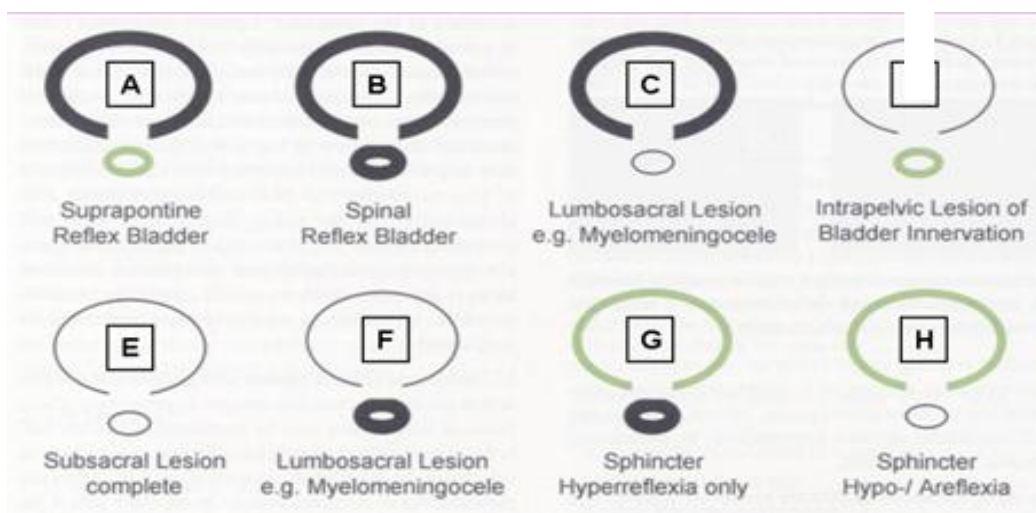

Figure 5. Madersbacher classification system with typical neurogenic lesions (Modified from Madersbacher et al<sup>30</sup>)

Heavy lines symbolize overactivity, thin lines underactive or acontractile and green lines normal function of the relevant structure



# Diagnostics in neurourology

Jean- Jacques Wyndaele

MD D Sci PhD FISCOS FEBU

1

## What we need to know in neurologic LUT function comes from the 5 commandments of neurourology

- Longterm renal function depends greatly on LUT function
- A main factor in LUT function is **PRESSURE**
- Bladder emptying is as important as bladder filling
- Proper treatment from day 1
- **No infection, no incontinence ≠ safe**

2

## Listing up methods for diagnosis in neurologic LUT dysfunction and neurologic urinary incontinence

- **History**
  - Questionnaires
  - Quality of life
- **Clinical examination**
- **Laboratory tests**
- **Function evaluation as with urodynamics**
- **Neurological evaluation as with electrodiagnostic tests**
- **Imaging/endoscopy**

3

## Last reflections before start

- LUT problems in neurologic patients relate not necessarily to the neurologic pathology. Other diseases such as prostate pathology, pelvic organ prolaps .. might also have an influence.
- Make diagnostic workout only as needed (to tailor an individual treatment) e.g. patients with suprapontine lesions or where treatment merely will consist of bladder drainage due to bad medical condition, limited life expectancy and such.

4

## History

- **What is the neurological diagnosis (MS, Parkinson, CVA, SCI ....)**
- **Since when**
- **What is the extent/ grade of the lesion**
- **What is the disease progression**
- **Female-male-age**
- **General condition**
  - Somatomotor
  - Central-brain

5

## History

- **Previous history**
- **Family history**
- **Previous treatments (drugs, surgery, catheterization)**
- **Quality of life**
- **Social situation (family, work, financial)**

6

## History

- Symptoms and signs (questionnaires)
  - Sensation of bladder
  - Leaking
  - Infections
  - Bladder emptying
- Bowel function
- Sexual function

7

## Clinical investigation

- General examination; scars, bulking areas, weight
- Motor function
- Mobility
- Perineal area :
  - Skin
  - External genitalia

8

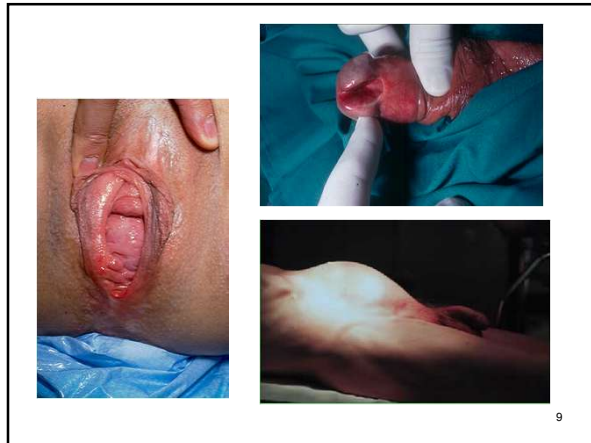

9

## Clinical neurological examination

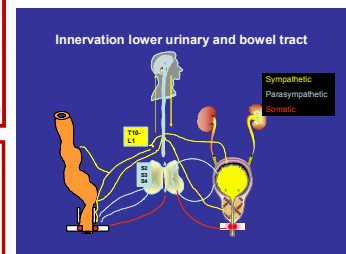
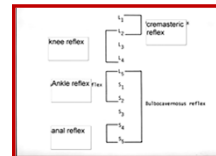
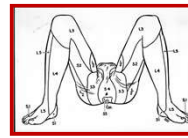

Voluntary control of anal sphincter and perineal muscles

## Correlation clinical examination and LUT function

- **NOT GOOD** in children with **lumbosacral myelodysplasia**:  
 Wyndaele and De Sy J Urol, 133: 638, 1985; Marshall and Boston Eur J Pediatr Surg, 11 Suppl 1: S21, 200135
- **Fairly GOOD** in individuals with **spinal cord lesion but with restrictions**
  - between thoracic 10 and lumbar 2

11

## Correlation in CVA in men, at risk for obstructive uropathy

- The cause of voiding dysfunction **could** be predicted by the type (obstructive or irritative) or time of onset of symptoms.
- Presenting symptoms predict **NOT** the urodynamic findings of bladder outlet obstruction or DOA

Nitti et al J Urol, 155: 263, 1996



12



## Summary clinical examination

- Is mandatory
- Reveals information on innervation in neurologic lesions
- Clinical value different in different pathologies

13

## Laboratory tests

- Urine test + culture
- Blood test
  - Indicative for kidney function
  - Indicative for chronic inflammation
  - ---

14

## Urodynamic tests

- enough evidence that these tests are valuable in neurologic urinary problems

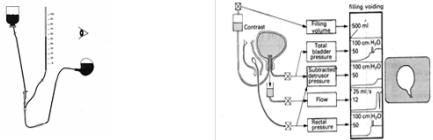

15

## Urodynamic tests

- Do them dynamically = adapted to the individual and the symptomq
- Try to get an answer to why there is incontinence, recurrent infection, diverticula formation..

16

## Urodynamic methods Cystometry filling rate

- Natural fill cystometry (NFC) : TIME!!
- Less filling speed in hyperreflexic neurologic bladders corresponds with lower MPdet and increase in compliance. (10ml/min)
- No significant differences in hyporeflexic or areflexic neurologic bladders

• De Gennaro et al 1996, Zermann et al 1997, Ko et al 2002.

17

## Urodynamic testing

- Re do if treatment evaluation is needed (pressure!!!)
- RE do if treatment outcome is not good (incontinence)

18

## + EMG ?

- **Diagnosis incomplete emptying** Mayo, Kiviat 1980
- **Dyssynergia** Sundin, Petersen 1975
- **Types dyssynergia** Blaivas et al 1981
- **Differentiate between pelvic nerve injury, distal autonomic neuropathy, progressive autonomic failure - multiple system atrophy, and idiopathic Parkinson's disease.** Aoki et al 1985



19

- **Pressure-flow study: obstructive pattern (high pressure voiding) also in neurologic patients**

### • **Video urodynamics**

- clear image of bladder neck and urethral sphincter activity during filling and voiding
- Anatomy of LUT, reflux, calculi,...

20

## Urodynamic filling sensation

- impaired perception of bladder filling during CMG is a sign of neuropathy
- Complete AIS A SC lesion: sensation of bladder filling during cystometry in 26 %.
- Myelodysplasia the perception of bladder filling present in a majority of patients  
Wyndaele 1992,1993
- **Bladder-filling sensation investigations reproducible** Ersoz and Akyuz 2004

21

## Specific tests

- Ice water test
- Bethanechol supersensitivity test
- Electrodiagnostic tests
- Electrosensitivity in the LUT
- Sympathetic skin response
- ....

22

**Electrodiagnostic tests : EMG of Sphincter, Dynamic Bulbocavernosus reflex (BCR), Nerve conduction studies, Somatosensory evoked potentials (SSEP),Electrosensitivity in the LUT and Sympathetic skin response**

- can be of value. The indications, limitations need to be understood. A proper application is mandatory to get good diagnostic value.

23

## Imaging -endoscopy

- **Ultrasonography : image of kidneys and LUT (also follow up)**
- Isotopes
- Xrays –MRI
- **Endoscopy: when previous diagnosis did not explain symptoms and signs**

24

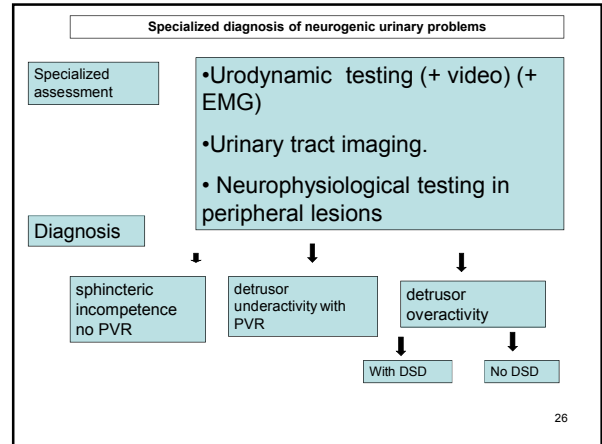
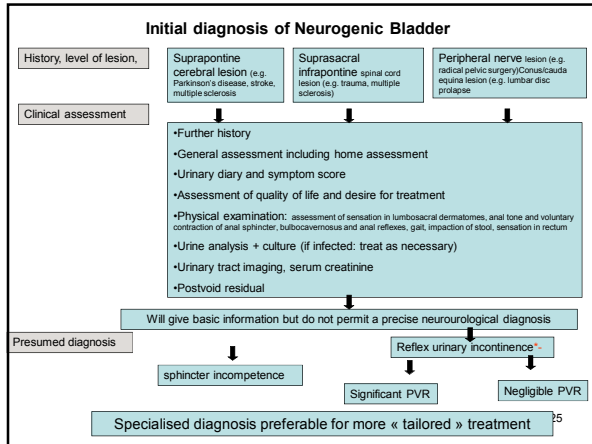

## **HOW TO MAINTAIN NORMAL RENAL FUNCTION, HOW TO ACHIEVE CONTINENCE, HOW TO MANAGE INCONTINENCE**

### **THERAPEUTIC STRATEGIES in 2011**

H. Madersbacher (Innsbruck, Austria)

The two aims in the management of patients with neurogenic lower urinary tract dysfunction (LUT-dysfunction) are (1) to protect the upper urinary tract to guarantee adequate (normal) life expectancy, and (2) achieve continence or to manage incontinence for improving their quality of life.

The most important objective is to achieve a safe situation urodynamically, which requires a bladder of sufficient capacity, filling at low pressure and emptying fully without hyperpressure or obstruction of the outlet. The indication for a therapeutic option must be based on the underlying pathophysiology, on risk-factors involved, however, also disease specific considerations as well as the abilities and the needs of the individual patient must be taken into account.

Depending on the localization and the extent of the neurological lesion, the detrusor and sphincter may react either with overactivity or underactivity (acontractility), mostly both, detrusor and sphincter, are affected.

## How to maintain normal renal function...

### With overactive detrusor

Piotr Radziszewski

Professor of Urology

Department of Urology, Medical University of Warsaw, Warsaw, Poland

e-mail:pradziszewski@wum.edu.pl

How to maintain normal renal function, how to achieve continence / to manage incontinence

*Therapeutic strategies in 2011*

### With overactive detrusor

+ *overactive sphincter*

+ *underactive sphincter*

+ *normal sphincter*

The micturition cycle is organised via a simple on-off switching circuit that maintains a reciprocal relationship between the urinary bladder and the urethral outlet. During bladder filling and urine storage, three functions must occur: (a) the bladder must continue to maintain low pressure and accommodate an increasing volume of urine, (b) the bladder outlet must remain closed, and (c) there should be an absence of involuntary bladder contractions. In contrast, during bladder emptying/voiding three things must happen: (a) the bladder must contract for an adequate magnitude and duration, (b) a concomitant lowering of resistance at the level of smooth and striated sphincter must occur, and (c) there must be an absence of anatomic obstruction.

Voiding dysfunction may occur from damage to the micturition reflex at the storage level or at the elimination level. Thus, voiding dysfunction may be categorized as the failure to store urine or the failure to empty secondary to the bladder or the outlet. In addition, a mixture of both of these classifications can exist.

Madersbacher classification system combines type of dysfunction with its level.

Lesions could be either **spinal** or **supraspinal**, with further diversification possible.

In **supraspinal** lesions urinary incontinence results from uninhibited detrusor contractions.

Neurogenic detrusor overactivity results from damage to the cerebral inhibitory centers. Patients with lesions above the level of the pons characteristically demonstrate synergetic activity of the external sphincter with detrusor activity. Patients with suprapontine lesions may, however, *purposely* increase sphincteric activity during an uninhibited detrusor contraction to avoid urge incontinence. This guarding reflex or *pseudo-dyssynergia* may be confused with true dyssynergia by those less familiar with the interpretation of urodynamic studies.

In the absence of other urinary disease, such as outflow obstruction, as long as external sphincter activity remains coordinated with detrusor contraction, intravesical pressure should remain physiologic and therefore preserve the function of the urinary tracts. Residual urine may either be due to a coexisting infravesical obstruction, rigidity and spasticity of the pelvic floor (e.g. Parkinsons

Disease) or due to a voluntary contraction of the external sphincter to control unhibitable detrusor contractions, a phenomenon, which has already become a reflex pattern in some patients.

A frequent reason for supraspinal neurogenic detrusor overactivity, causing reflex incontinence are cerebrovascular accidents. A significant number of new stroke patients develop urinary retention for several weeks before neurogenic detrusor overactivity occurs. This phase of detrusor areflexia may be named “cerebral shock” much alike the classic “spinal shock” phase immediately after a spinal cord injury. Parkinsons Disease is one of the most common neurological entities causing voiding dysfunction, classically resulting in neurogenic detrusor overactivity, sphincter bradykinesia and an impairment of relaxation of the striated sphincter. Another reason for supraspinal reflex incontinence is dementia. The defect in cognitive function is responsible for the lack of social continence in these patients. In brain neoplasms alterations in lower urinary tract function tend to relate directly to the area of the brain affected.

Shy and Drager described a neurological syndrome characterized by autonomic dysfunction consisting of orthostatic hypotension, anhydrosis, impotence, extrapyramidal symptoms and poor urinary and fecal control, however, the term mutiple system atrophy nowadays involves various syndroms, resulting in degeneration of neurons and associated fibers of motor and extrapyramidal systems including the cerebellum and brain stem. The urinary symptoms of incontinence are primarily caused by neurogenic detrusor overactivity although some element of external sphincter weakness may be present, with an open bladder neck during cystography indicating peripheral sympathetic dysfunction. The combination of detrusor dysfunction and sphincter denervation contraindicates the surgical management of symptoms .

In supraspinal lesions neurogenic detrusor overactivity is mostly combined with normal sphincter function, reflex incontinence is the main symptom and anticholinergic therapy togheter with behavioural treatment, especially in patients with cognitive impairment, is the method of choice.

In **spinal cord lesions** the degree of dysfunction is related to the disease process itself, the area of the spinal cord affected by the disease, and the severity of neurological impairment. Neurological injury, which can involve parasympathetic, sympathetic, and somatic nerve fibers, can result in a complex combination of signs and symptoms.

In multiple sclerosis voiding dysfunction is mainly due to spinal lesions, although cerebral lesions may contribute. Impairment of neurological function results from demyelinating plaques of the white matter of the brain and spinal cord, especially the posterior and lateral columns of the cervical cord, which serve as pathways for neurologic control over vesical and urethral function. Symptoms of voiding dysfunction are appreciated by 90% of patients having the disease more than 10 years. These include not only frequency, urgency, and urge incontinence, but also urinary hesitancy, intermittency, and poor urinary stream.

Beside these most important reasons many other neurological lesions, affecting the spinal cord, may cause storage and emptying problems, e.g. transverse myelitis or the tethered cord syndrom, caused by a short filum terminale, intraspinal lipoma or fibres adhesions resulting from the surgical repair of spinal dysraphism.

In **suprasacral lesions** the combination of a **overactive detrusor with a hyperreflexic sphincter** is characteristic for the **spinal reflex bladder**. Basically spontaneous reflex voiding is possible, however, it is uncontrolled, causing *reflex-incontinence* and is mostly unbalanced and basically unphysiologic. Detrusor contractions are mostly inadequate, and detrusor striated sphincter dyssynergia is present, both leading to unbalanced voiding.

Neurogenic detrusor overactivity (NDO) could cause incontinence and or renal functions impairment. The key factor is the sphincteric function. Therefore management of patients with NDO should always focus on both bladder and outflow region.

The following scenarios are possible:

- 1.NDO and sphincteric underactivity
- 2.NDO and normal sphincteric functions
- 3.NDO and sphincteric overactivity

These scenarios could be further combined with normal or underactive functions of the detrusor during voiding.

When managing patients with neurogenic lower urinary tract dysfunction, preservation of normal kidney functions is an ultimate goal, with continence and quality of life restoration afterwards. It is also important to state if the dysfunction is due to complete or incomplete lesion, since it will influence further treatment and follow-up options.

To achieve the primary goal we must focus on maintenance low intravesical pressure and low post-void residual. Therefore before elaboration of the treatment strategies for treatment of the patients with NDO we have to establish these parameters and evaluate the sphincteric functions, as well as establish the kidney functions.

The minimal assessment program should include:

- ultrasound examination
- dipstick and urine culture
- serum kreatinine levels
- voiding cystourethrography
- basic urodynamics (both filling and voiding phase)

In selected cases, when the original therapy fails or when a worsening of kidney functions is observed the following diagnostic tests could be performed additionally:

- video urodynamics
- enhanced lower urinary tract CT or intravenous urography
- dynamic tests of kidney functions
- detailed neurphysiological tests

### **1.Neurogenic detrusor overactivity and normal sphincteric function treatment.**

When the sphincter acts in a coordinated way and no (or minimal - less than 25% of cystometric capacity) post void residual exists the treatment strategy is directed at lowering the intravesical pressure, achievement of continence and monitoring of adequate bladder emptying.

The treatment strategy should be staged from non (minimally) invasive to invasive one:

- 1.Behavioural modifications, bladder training in combination with anticholinergics
- 2.Botulinum toxin injections

- 3. Neuromodulation with implantable devices
- 4. Bladder surgery (for very selected cases)

It is important to inform the patient that the therapy is life-long and a check-up of renal and bladder functions should be performed regularly/at least every 1-2 years in stable conditions /

Follow up of a patient with NDO and normal sphincteric functions is very much dependant on the underlying neuropathology and ICI guidelines how to follow-up a patient with specific neurogenic disease should be observed. For patients with complete lesion it is advisable to proceed promptly for more radical and definitive treatment options (surgery, neuromodulations) .

Worsening of incontinence, recurrent urinary tract infections, increased post void residual, hydronephrosis should trigger the detailed examination of the lower urinary tract for worsening of existing pathology or appearance of the new one.

## **2. Neurogenic detrusor overactivity and underactive sphincteric functions.**

In this case we have a combination of both stress and urge incontinence, occasionally accompanied by detrusor underactivity during voiding.

Kidney failure is very rare and the cornerstone of therapeutic strategy should be focused on incontinence and monitoring of adequate bladder emptying.

The therapy for NDO should be staged as usual (see above), however one must bear in mind the parallel therapy for stress incontinence.

The concomitant stress incontinence therapy should also be staged:

1. Behavioral therapy and physiotherapy

2. Minimally invasive surgery:

injectables

micro-balloons

mid-urethral slings

bladder neck slings

artificial urinary sphincter

In almost every case, except injectables, it is important to discuss with the patient the possibility of self-catheterization after surgery, and no patient could be qualified for stress incontinence surgery without demonstrating the willingness and ability for self-catheterization.

Stress incontinence surgery could worsen detrusor overactivity and lead to more invasive treatment options (including surgery), and this scenario should also be discussed with a patient. Sometimes it is better to have patient with minimal stress incontinence, than to face the stress incontinence surgery complications.

Patients with complete lesion should be managed accordingly to their disability status and kidney functions. Generally more radical treatment options (e.g. artificial sphincter with botulinum toxin or bladder surgery) are advisable.

Follow up of a patient should again observe the ICI guidelines for specific neuropathy.

Additionally, patients after the surgery for stress incontinence should be checked at least yearly for post-void residual and should have performed urodynamics.

If overactivity is worsening (despite staging the overactivity treatment) one must consider urethrolisis, even if this would make the patient incontinent again.

## **3. Neurogenic detrusor overactivity and sphincteric overactivity.**



This situation represents the worst case scenario, which most often leads to chronic kidney failure. Therefore the treatment goal is the preservation of kidney function, while the quality of life issues (and incontinence) are of secondary importance.

Again staged approach (see above) for therapy of NDO should be observed, however the second and third line therapy should be considered much earlier.

The following treatment options for sphincteric overactivity could be considered:

1. Pharmacotherapy (minimally effective)
2. Botulinum toxin injections (for both NDO and sphincteric overactivity)
3. Neuromodulations (for both NDO and sphincteric overactivity)
4. Intraurethral stents
5. Sphincterotomy

Self-catheterization /either sterile or aseptic/ still remain the "golden standard" for the sphincteric overactivity treatment and should always be considered for this type of patients.

Complete lesion patients should be managed by definitive treatment options (botulinum toxin therapy or bladder surgery combined with self catheterization) and neuromodulation with implants should always be considered.

Follow-up should be performed accordingly to the ICI guidelines and additionally PVR, kidney function and bladder functions (urodynamics or video urodynamics) should be performed yearly or when a deterioration of incontinence or kidney functions is observed.

Suggested literature:

Birder L, de GW, Mills I, Morrison J, Thor K, Drake M. Neural control of the lower urinary tract: peripheral and spinal mechanisms. *Neurourol Urodyn* 2010; 29:128-139.

Abrams, P., Cardozo L., Koury S., Wein A. Incontinence. 4<sup>th</sup> edition 2009. Health Publication Ltd 2009. Neurologic Urinary and Faecal Incontinence. J.J. Wynadaele, A. Kovindha, H. Madersbacher, P. Radziszewski, A. Ruffion, B. Schurch, 793-960.

Stohrer M, Blok B, Castro-Diaz D, Chartier-Kastler E, Del PG, Kramer G, Pannek J, Radziszewski P, Wynadaele JJ. EAU guidelines on neurogenic lower urinary tract dysfunction. *Eur Urol* 2009; 56:81-88. Madersbacher HG. Neurogenic bladder dysfunction. *Curr Opin Urol* 1999; 9:303-307.

Resnick NM, Yalla SV, Laurino E. The pathophysiology of urinary incontinence among institutionalized elderly persons. *N Engl J Med* 1989; 320:1-7.

Sakakibara R., Hattori T., Yasuda K., Yamanishi T. Micturitional disturbance after acute hemispheric stroke: analysis of the lesion site by CT and MRI. *J Neurol Sci* 1996c; 137: 47-56.

Ukkonen M., Elovaara I, Dastidar P., Tammela TL. Urodynamic findings in primary progressive multiple sclerosis are associated with increased volumes of plaques and atrophy in the central nervous system. *Acta Neurol Scand.* 2004 ; 109 : 100-105

Araki, I., Matsui, M., Ozawa, K., Nishimura, M., Kuno, S., Saida, T.: Relationship between urinary symptoms and disease-related parameters in multiple sclerosis. *J Neurol*, 2002, 249: 1010-1018, Ciancio S.J., Mutchnik St. E., Rivera V.M., Boone T.B. Urodynamic pattern changes in Multiple Sclerosis. *Urology*, 2005, 67: 239-245

Pagliacci MC, Celani MG, Zampolini M, Spizzichino L, Franceschini M, Baratta S et al. An Italian survey of traumatic spinal cord injury. The Gruppo Italiano Studio Epidemiologico Mielolesioni study. *Arch Phys Med Rehabil* 2003; 84(9):1266-1275.

Weld KJ, Dmochowski RR. Association of level of injury and bladder behavior in patients with post-traumatic spinal cord injury. *Urology* 2000; 55(4):490-494.

Gerritzen RG, Thijssen AM, Dehoux E. Risk factors for upper tract deterioration in chronic spinal cord injury patients. *J Urol* 1992; 147:416-418.

Beck RO, Betts CD, Fowler CJ. Genitourinary dysfunction in multiple system atrophy: clinical features and treatment in 62 cases. *J Urol* 1994; 151(5):1336-1341.

Stocchi F, Carbone A, Inghilleri M, Monge A, Ruggieri S, Berardelli A et al. Urodynamic and neurophysiological evaluation in Parkinson's disease and multiple system atrophy. *J Neurol Neurosurg Psychiatry* 1997; 62(5):507-511.

Chancellor MB, Anderson RU, Boone TB Pharmacotherapy for neurogenic detrusor overactivity. *Am J Phys Med Rehabil*. 2006 Jun;85(6):536-45.

Lemke JR, Kasprowicz K, Worrall PS. Intermittent catheterization for patients with a neurogenic bladder: sterile versus clean: using evidence-based practice at the staff nurse level. *J Nurs Care Qual* 2005; 20:302-306

## THE MANAGEMENT OF THE UNDERACTIVE / ACONTRACTILE DETRUSOR

- + underactive sphincter
- + overactive sphincter
- + normal sphincter

Helmut Madersbacher (Innsbruck, Austria)

*According to ICS terminology (2002) detrusor underactivity is defined as a contraction of reduced strength and/or duration, resulting in prolonged bladder emptying and/or a failure to achieve complete emptying within a normal timespan. Acontractile detrusor is one that can not be demonstrated to contract during urodynamic studies. Although not defined by the ICS as a detrusor with a maximum detrusor pressure (pdetr. max.) below 30 cm H<sub>2</sub>O in men and 15 cm H<sub>2</sub>O in women can be considered to be underactive.*

The reasons for an underactive detrusor are several. In the context of neuropathology detrusor acontractility or detrusor underactivity are usually observed with damage of (1) the lumbosacral spinal cord, (2) the bladder peripheral efferent pathways, (3) the bladder peripheral afferent pathways and (4) maybe due to a secondary myogenic failure.

There are various options for the management of the underactive /acontractile detrusor, depending also on the function/dysfunction of the sphincter and whether the lesion is complete or incomplete.

### 1. MANAGEMENT OF THE ACONTRACTILE / UNDERACTIVE DETRUSOR COMBINED WITH AN UNDERACTIVE (INCOMPETENT) SPHINCTER

*In complete lesions, the bladder and the striated sphincter as well as the pelvic floor musculature are acontractile. As the bladder capacity is high and the intravesical pressure is low, the kidneys are not at risk as long as regular low pressure emptying is provided. However, neurogenic stress incontinence due to the incompetent sphincter is a problem.*

#### **How to empty the bladder**

- **Bladder expression**

Bladder expression has been recommended since a long time for these patients. With bladder expression (Valsalva or Credé manoeuvre) often unphysiologic high intravesical pressures are created. The reasons for difficulties in expressing the urine from the bladder are the difficulties to open the bladder neck and a functional obstruction at the level of the pelvic floor despite complete flaccid paralysis, resulting in deformation and narrowing of the membranous urethra (Madersbacher, 1975).

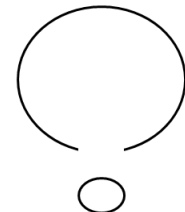

**Sacral / Subsacral  
Spinal Lesion**

Therefore, bladder expression is potentially hazardous for the urinary tract. Before recommending bladder expression it must be proved that the situation in the LUT is urodynamically safe. Contraindications, such as vesico-uretero-renal reflux, prostatic reflux, urethral pathology, hernias, have to be excluded. **In general, bladder expression should be replaced by CIC in most patients.** Alpha-blockers may facilitate voiding, however, urinary stress incontinence may be induced or increased. Therefore Valsalva and Credé only guarantee a good quality of life and are cost effective in long term when the indication is proper and when the situation remains stable throughout the years, best controlled by (video-)urodynamics.

- **Pharmacotherapy**

So far there is no randomized controlled study which proves the efficacy of cholinergics. They are not able to induce/increase detrusor contractions, however they seem to increase the muscle tone of the detrusor. The patient may feel the bladder at a lower filling volume.

Lowering of outflow resistance is another option to facilitate bladder expression. However, there is no controlled trial, which really proves the efficacy of alpha-blockers. Dosages of spasmolytics needed for the relaxation of striated sphincter are often not tolerated because of side effects, especially general muscle weakness.

- **Intermittent catheterisation**

In complete lesions with detrusor acontractility therefore for many patients the method of choice to empty the bladder is intermittent catheterisation, either using the sterile or the hygienic technique.

- In **incomplete lesions** with preserved afferent fibres, **intra-vesical electrostimulation (IVES)** is useful to induce or to improve sensitivity and contractility of the detrusor (s. below).

### ***How to manage neurogenic stress incontinence***

The other problem with this type of neurogenic LUT dysfunction is the underactive, incompetent sphincter causing neurogenic urinary stress incontinence.

- **Behavioural therapy**

Neurogenic urinary stress incontinence can be improved to a certain degree by regular bladder emptying, controlled fluid intake and the avoidance of urinary tract infections.

- **Pharmacotherapy**

There is no controlled trial which really proves the efficacy of  $\alpha$ -adrenergics in neurogenic urinary stress incontinence. Whether the 5-HT and NA-Reuptake inhibitor Duloxetine is able to improve neurogenic stress incontinence in incomplete lesions, still needs to be proved through studies.

- **Surgery**

Especially in "walkers" continence can only be restored through operative treatment. Although the design of the artificial sphincter has improved considerably over the years, there is still a complication rate of about 30 % in these patients on the long term. In women the risk of erosion at the bladder neck is high, overall long-term continence is satisfactory with about 90 % (Venn et al., 2000). Prerequisites for the implantation of an artificial urinary sphincter is neurogenic stress incontinence, an acontractile detrusor (can be achieved by pharmacotherapy or other procedures), a motivated patient and adequate manual dexterity. Moreover, the system has to be replaced between 10 and 15 years after implantation. For women sling procedures (fascial slings) are also recommended.

- **Condom catheters and external appliances**

Despite all efforts, some patients with neurogenic bladder and urinary incontinence need some kind of assistance to gain social continence. In males, a condom catheter (CC) has been one of the choices. Until now, a wide variety of condom catheters has been available, such as a simple thin latex, plastic or silicon condom catheters or a condom catheter with a double rows of convulsions near the catheter tip to prevent kinking, with an inner flap to prevent the backflow of the urine to the shaft of the penis and an inner wall coated with a self-adhesive. Even a special condom with a passage for catheterization without removal of the condom has been developed. Condom catheters still play a role in the control of urinary incontinence in male patients. Long-term use may cause bacteriuria, but does not increase the risk of UTI compared to other methods of bladder management. Complications may occur less often if the condom catheter is applied properly, and if all hygienic measures necessary are taken, i.e. frequent (daily) change of the condom catheter and maintenance of a low bladder pressure. To prevent a latex allergy, which is becoming more and more common, a silicone condom catheter should be used. To prevent compressive effects the

proper size of the condom catheter with self-adhesive is recommended. Moreover, in order to prevent bladder and upper urinary tract damages regular bladder emptying with low bladder pressure and low PVU should be pursued also when a condom catheter is used. In incomplete lesions pelvic floor reeducation may help in the individual patient.

## 2. MANAGEMENT OF THE ACONTRACTILE / UNDERACTIVE

### DETRUSOR COMBINED WITH AN OVERACTIVE (“SPASTIC”, “HYPERREFLEXIC”) SPHINCTER

This pattern can be seen with lesions at the conal and epiconal level of the spinal cord, e.g. in myelodysplastic children. The main problem is bladder emptying, the overactive sphincter secures continence, provided that the bladder is emptied regularly.

- **Intermittent (Self-)catheterisation**

This dysfunctional pattern is a clear indication for intermittent (self-) catheterisation which provides regular bladder emptying with low pressure and the spastic sphincter secures continence in between.

In **incomplete lesions** the underactive and hyposensitive detrusor is a good indication for intravesical electrostimulation (see below) to achieve bladder sensitivity, however, balanced voiding is mostly not achieved due to sphincter spasticity. Lowering of outflow resistance caused by the spastic striated sphincter is difficult to achieve (see above). Sacral nerve stimulation (SN5) should be considered to improve voiding (referral to a specialized center).

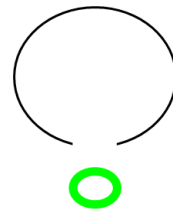

**Intrapelvic Lesion**

## 3. MANAGEMENT OF THE ACONTRACTILE / UNDERACTIVE

### DETRUSOR COMBINED WITH A NORMALLY FUNCTIONING SPHINCTER

This pattern is seen with peripheral lesions of bladder innervation especially after pelvic surgery. As the pelvic plexus contains both parasympathetic and sympathetic fibres, decreased parasympathetic innervation may result in decreased detrusor contractility or acontractility, while impaired sympathetic transmission results in incomplete bladder neck closure with weakness of the smooth muscle sphincter. After pelvic surgery urinary retention may occur and **intermittent catheterisation** is the method of choice, however reeducation of the bladder should be aimed as the **lesions are mostly incomplete**. Again **intravesical electrostimulation** is the method of choice to achieve or to speed up bladder rehabilitation. Also cholinergics in combination with alphablockers and with regular bladder emptying may be successful to achieve balanced voiding. Also sacral nerve stimulation should be considered to improve detrusor function (referral to a specialized center).

## 4. MANAGEMENT OF DETRUSORACONTRACTILITY IN THE SPINAL CORD INJURED PATIENT DURING THE SPINAL SHOCK PHASE

*The acute phase of the spinal cord lesion is characterized by the “spinal shock phase” with absent spinal reflexes below the lesion. The bladder is able to store urine, but the patient unable to void; unless appropriate measures are taken, overflow incontinence with bladder-overdistention, urinary tract infections and damage to the upper urinary tract will occur. Prevention of early complications, such as bladder overdistention, urinary tract infections, stone formations and urethral injury is a prerequisite for successful rehabilitation of lower urinary tract dysfunction.*

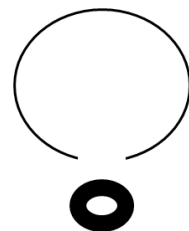

**Epiconal Lesion**

Securing of bladder emptying is of paramount importance. This can be done by intermittent catheterisation (IC), by a suprapubic catheter (SC) or by a transurethral indwelling catheter (ID), rarely adequate spontaneous voiding is possible in incomplete lesions.

**Intermittent catheterisation** has proved to have the lowest complication rate. The alternative of first choice is a **suprapubic catheter**, connected to a urine drainage bag. Only if a suprapubic catheter is contraindicated (injuries in the small pelvis, acute abdomen, pregnancy) **transurethral indwelling catheterisation** is indicated.

However, despite daily catheter care, changing of the catheter each week, continuous drainage into a closed urine collecting device and fixation of the penis at the abdomen near the groin to avoid a decubital ulcer in the urethra at the peno-scrotal angle, the rate of complications is high. Any catheter should be removed as soon as possible based on a daily decision.

## 5. LONG TERM-INDWELLING TRANSURETHRAL AND SUPRAPUBIC CATHETERS

The long-term use of indwelling catheters for the management of neuropathic bladder is not favorable due to unavoidable complications. In chronic patients, acceptable indications include impossibility to perform IC, uncontrollable urinary incontinence with problems in wearing continence devices (condom catheters) and in patients with an acute situation in the upper urinary tract including urosepsis. For long-term use, in general, a suprapubic catheter is preferable.

---

### References related to the topic and worthwhile to read:

1. Wyndaele JJ, Kovindha A, Madersbacher H et al.: Neurologic Urinary and Faecal Incontinence – In: Incontinence, Edts. Paul Abrams, Linda Cardozo, Saad Khoury, Alan Wein, 4<sup>th</sup> Edition 2009, p. 793-960, Health Publications Ltd. 2009.
2. Bladder management for adults with spinal cord injury: a clinical practice guideline for health-care providers. J Spinal Cord Med 2006; 29: 527-73.
3. Generao SE, Dall'era JP, Stone AR and Kurzrock EA. Spinal cord injury in children: long-term urodynamic and urological outcomes. J Urol 2004; 172: 1092-4, discussion 1094.
4. Kovindha A, Mai WN and Madersbacher H. Reused silicone catheter for clean intermittent catheterization (CIC): is it safe for spinal cord-injured (SCI) men? Spinal Cord 2004; 42:638-42.
5. Feifer A, Corcos J: Management of neurogenic bladder with suprapubic cystostomy. – In: Textbook of the neurogenic bladder. Edts. Jacques Corcos & Erik Schick, 2nd Edition, p. 564-569, Informa UK Ltd. 2008.
6. Madersbacher H. Intravesical electrical stimulation for the rehabilitation of the neuropathic bladder. Paraplegia 1990;28:349-352.
7. Madersbacher G H, Katona F, Berényi M: Intravesical electrical stimulation of the bladder. – In: Textbook of the neurogenic bladder. Edts. Jacques Corcos & Erik Schick, 2nd Edition, p. 624-629, Informa UK Ltd. 2008.
8. Wallace PA, Lane FL, Noblett KL. Sacral nerve neuromodulation in patients with underlying neurologic disease. Am J Obstet Gynecol 2007;197:96 e91-95.

9. van Kerrebroeck PE, van Voskuilen AC, Heesakkers JP, Lycklama a Nijholt AA, Siegel S, Jonas U, et al. Results of sacral neuromodulation therapy for urinary voiding dysfunction: outcomes of a prospective, worldwide clinical study. *J Urol* 2007;178:2029-2034.